



FEATURES

- Trench Schottky technology
- Lower forward voltage
- Lower power loss,high efficiency
- Softest, fast switching capability
- High surge capability
- Lead Free Finish,ROHS Compliant

TYPICAL APPLICATIONS

For use in high frequency rectifier of switching mode power supplies, freewheeling diodes, DC/DC converters or polarity protection application

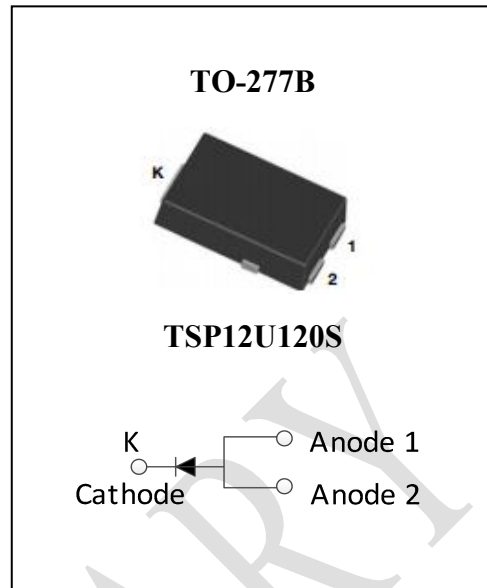

| PRIMARY CHARACTERISTICS | |
|-------------------------|-------|
| IF (AV) | 12A |
| VRRM | 120V |
| IFSM | 150A |
| VF | 0.61V |
| TJ max. | 150°C |

Maximum ratings and electrical characteristics (TA = 25 °C unless otherwise noted)

| Parameter | Description | Test Condition | Min. | Typ. | Max. | Unit | |
|-----------|---|--------------------|------------|------|------|------|----|
| VRRM | Maximum repetitive peak reverse voltage | IR = 500µA | 125 | 138 | — | V | |
| IF (AV) | Maximum average forward rectified current | | — | — | 12 | A | |
| IFSM | Maximum Peak forward surge current | 1/2 60hz | — | — | 150 | A | |
| VF | Static Forward Voltage | IF = 1A | TA = 25°C | — | 0.38 | 0.48 | V |
| | | IF = 12A | | — | 0.61 | 0.71 | V |
| | | IF = 1A | TA = 125°C | — | 0.19 | 0.30 | V |
| | | IF = 12A | | — | 0.56 | 0.66 | V |
| IR | Maximum reverse current per diode at working peak reverse voltage | VR = 120V | TA = 25°C | — | 14 | 30 | µA |
| | | | TA = 125°C | — | 13 | 30 | mA |
| RθJL | Typical Thermal Resistance | TO-277B | 3 | | | °C/W | |
| TJ, TSTG | Operating and Storage Temperature Range | -55°C to 150°C Max | | | | | |



RATINGS AND CHARACTERISTICS CURVES ($T_A = 25\text{ }^\circ\text{C}$ unless otherwise noted)

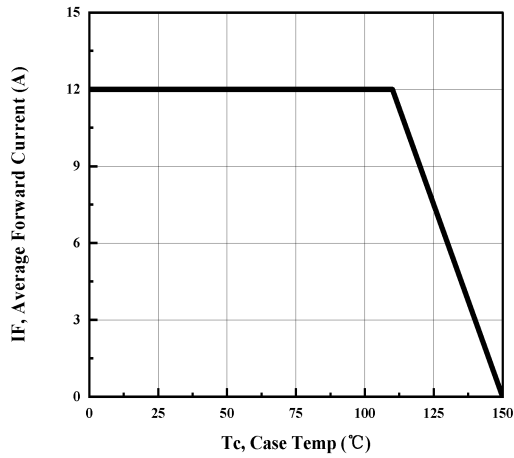

Fig. 1: Forward Current Derating Curve

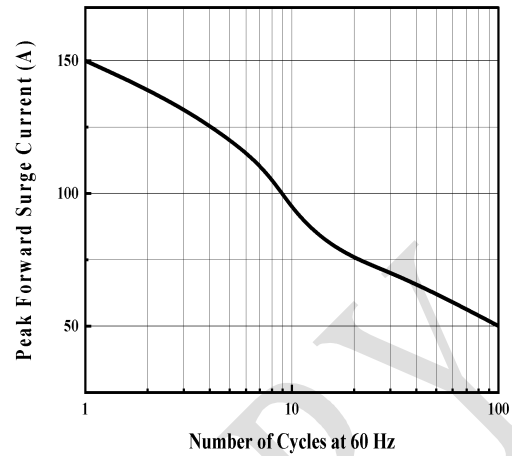

Fig. 2: Maximum Repetitive Surge Current

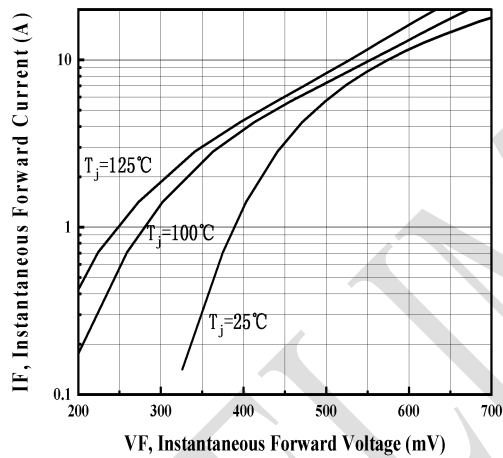

Fig. 3: Typical Forward Voltage

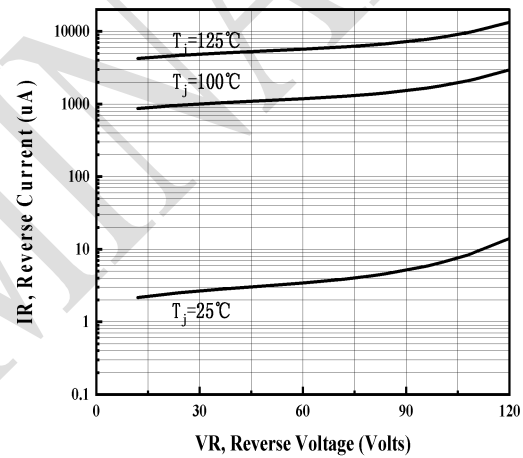

Fig. 4: Typical Reverse Current

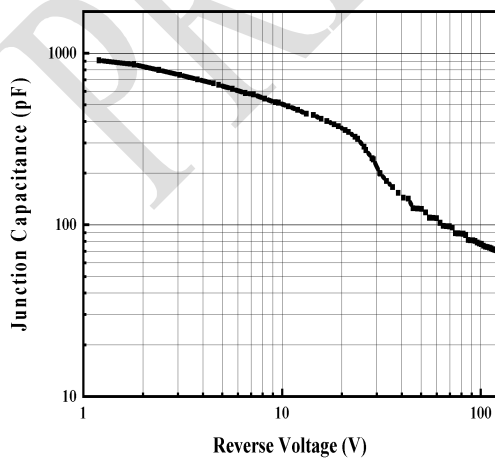
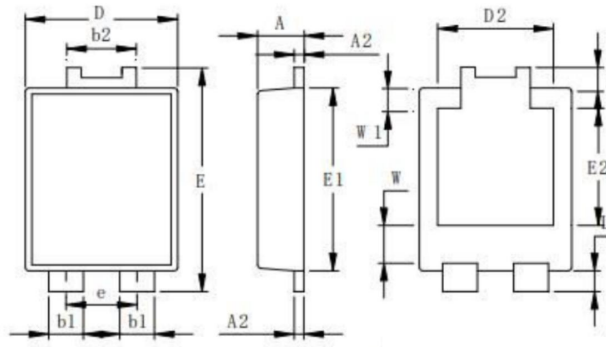

Fig. 5: Typical Junction Capacitance



PACKAGE OUTLINE DIMENSIONS in millimeters



TO-277B(TSP12U120S)

| NO | Min | Max | NO | Min | Max |
|----------------------|------|------|----|------|------|
| A | 0.95 | 1.25 | e | 1.78 | 1.98 |
| A2 | 0.25 | 0.35 | E1 | 5.28 | 5.48 |
| b1 | 0.85 | 0.95 | E2 | 3.39 | 3.69 |
| b2 | 1.75 | 1.85 | L | 0.41 | 0.71 |
| D | 3.93 | 4.13 | L1 | 0.41 | 0.71 |
| D2 | 2.85 | 3.15 | W | 1.44 | 1.74 |
| E | 6.30 | 6.70 | W1 | 0.05 | 0.45 |
| All Dimensions in mm | | | | | |

- ZHE technology reserves the right to make changes to this document and its products and specifications at anytime without notice.
- Customers should obtain and confirm the latest product information and specifications before final design, purchase or use.
- ZHE technology makes no warranty, representation or guarantee regarding the suitability of its products for any particular purpose, nor does ZHE technology assume any liability for application assistance or customer product design.
- ZHE technology does not warrant or accept any liability with products which are purchased or used for any unintended or unauthorized application.
- No license is granted by implication or otherwise under any intellectual property rights of ZHE technology.
- ZHE technology are not authorized for use as critical components in life support devices or systems without express written approval of ZHE technology.